

WPC Decking Floor Installation

WPC decking floor installation notes:

1. Make sure the ground foundation is flat, clean and strong enough before floor installation. It needs to be laid solid base on the ground. If it is mud ground, for later keel fixing use. And if it is a concrete ground, it should be ensured more than 6cm thickness, in case that the ground crack, subsidence or other situations happen.
2. If the concrete surface is a closed low-lying, make sure to keep a drain pipe between two keels by every 2.5 meters. And this drain pipe should be at a size of 8cm diameter linked to underground, so that to let the water drain away when it rains.
3. When the floor need to be installed in some special position, such as roof platform, it should be more careful and avoid destroy the waterproof layer.
4. All screws used during installation process should be stainless steel material, ensure that won't rust.

Installation guide for high strength wpc decking

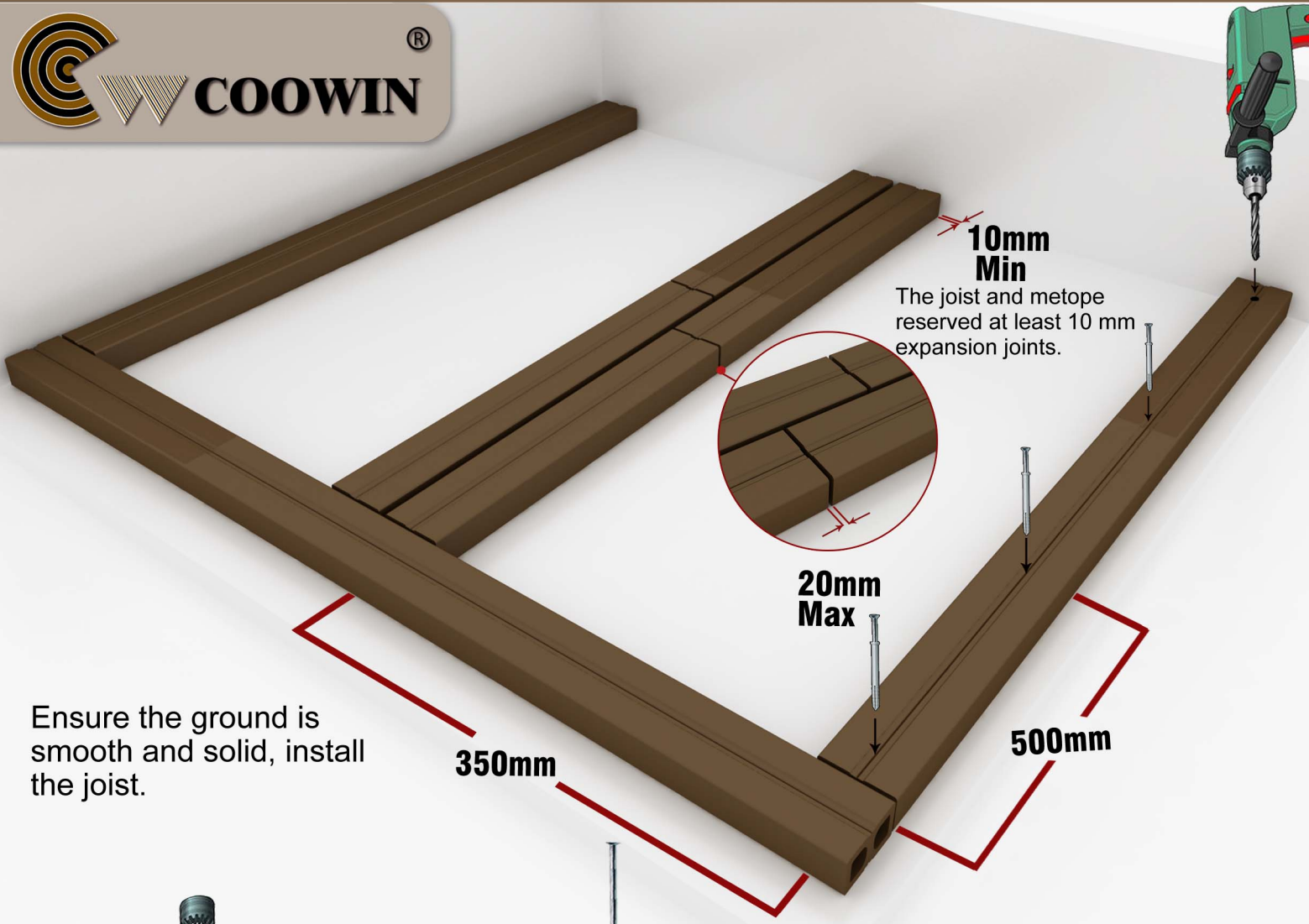

10mm Min
The joist and metope reserved at least 10 mm expansion joints.

20mm Max

350mm

500mm

Ensure the ground is smooth and solid, install the joist.

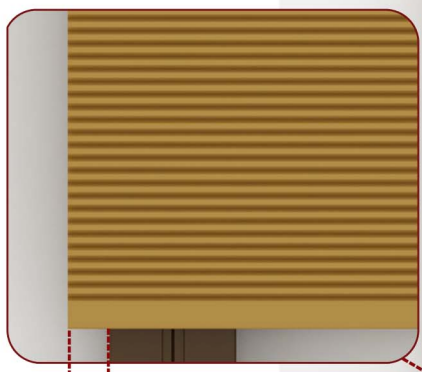
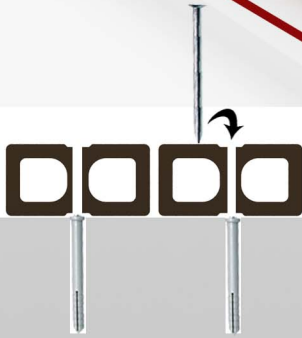

10mm Max

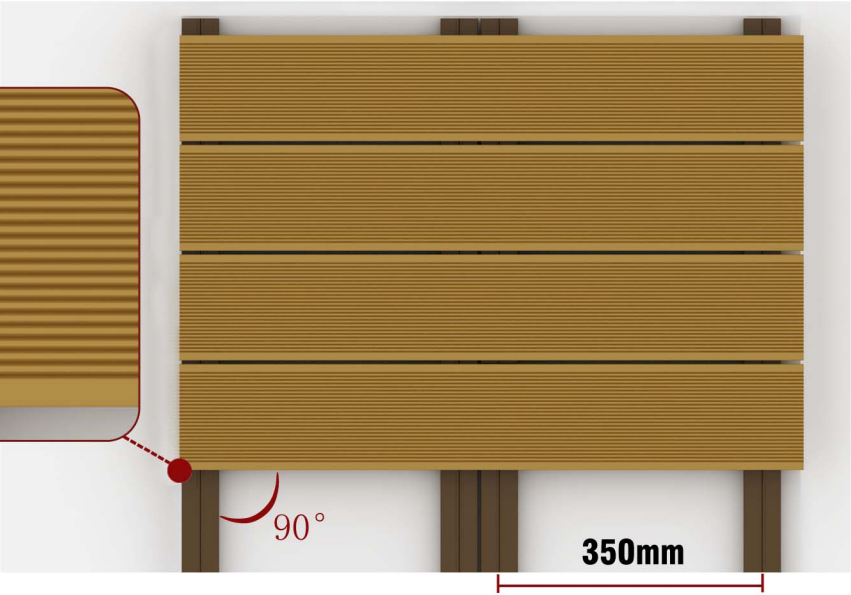

90°

350mm

Fixed joist

When installation, the WPC decking must be perpendicular to the joist.

Installation guide for high strength wpc decking

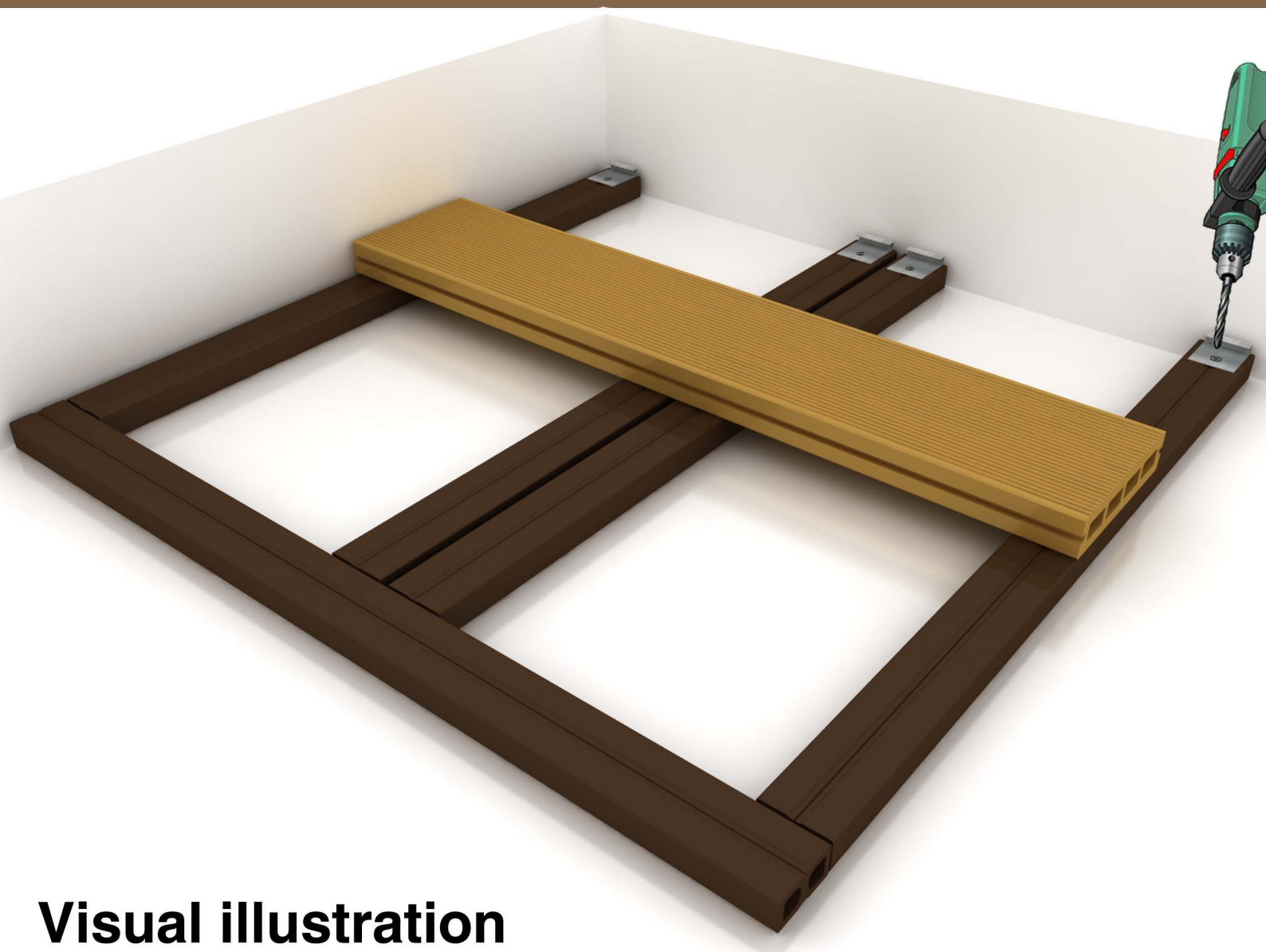

Visual illustration

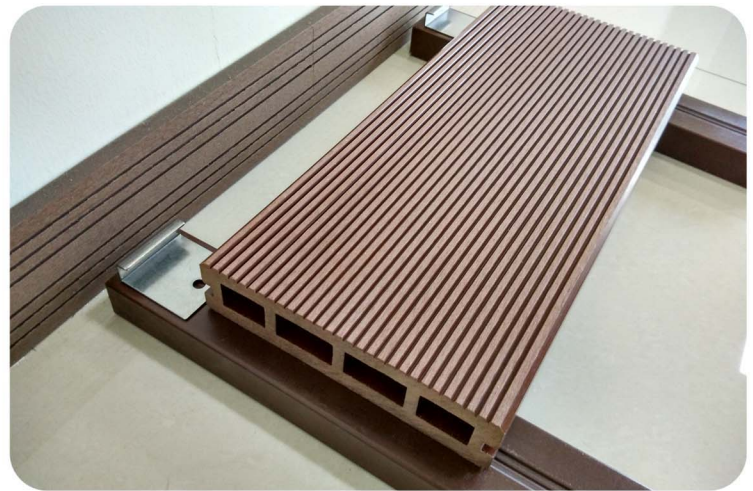

2

Composite Decking
COOWIN GROUP

Installation guide for high strength wpc decking

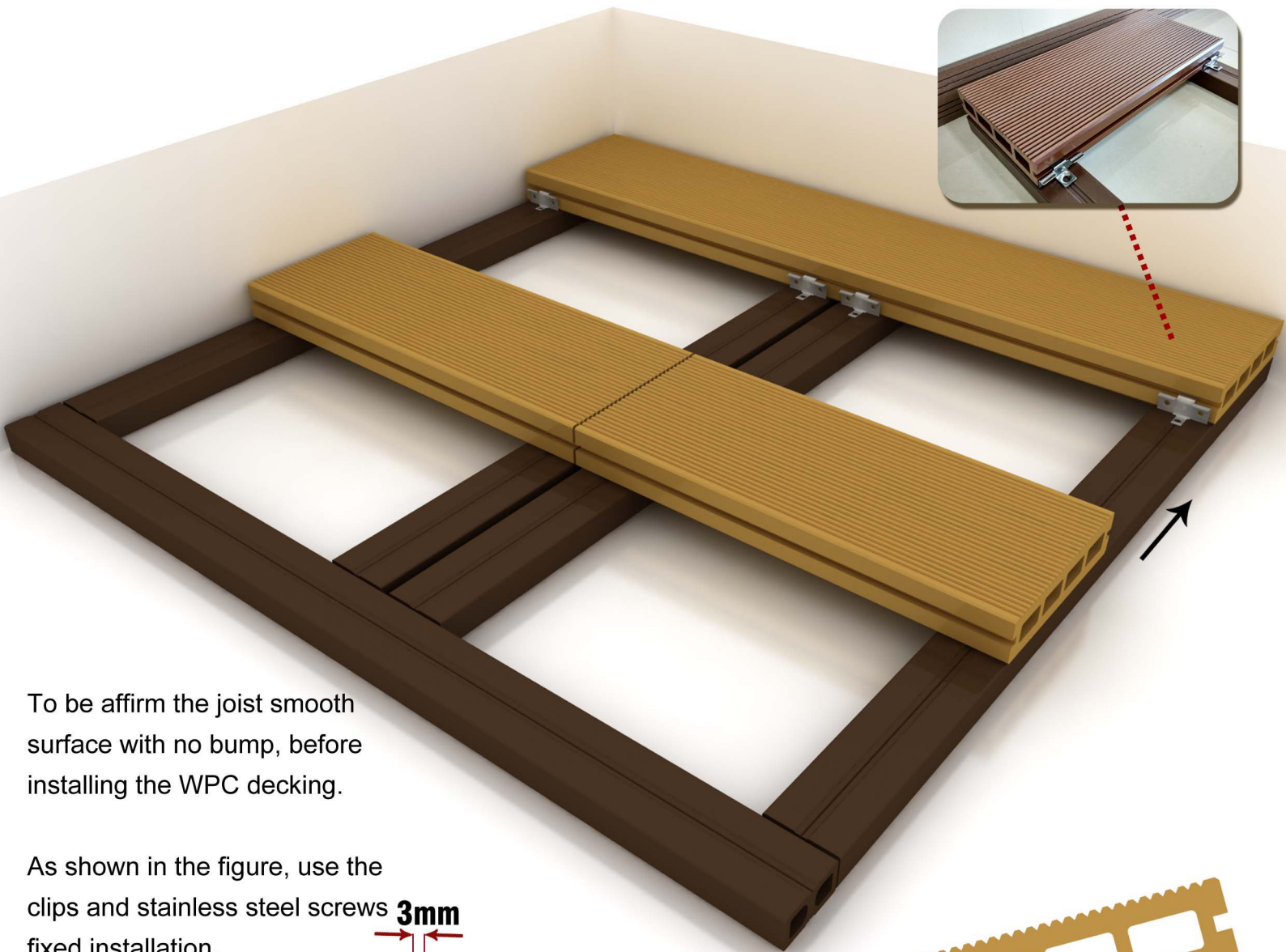

To be affirm the joist smooth surface with no bump, before installing the WPC decking.

As shown in the figure, use the clips and stainless steel screws **3mm** fixed installation.

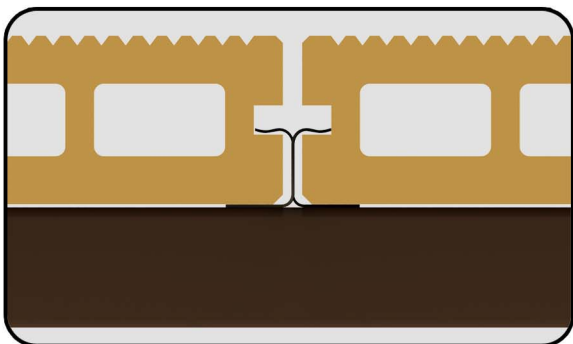
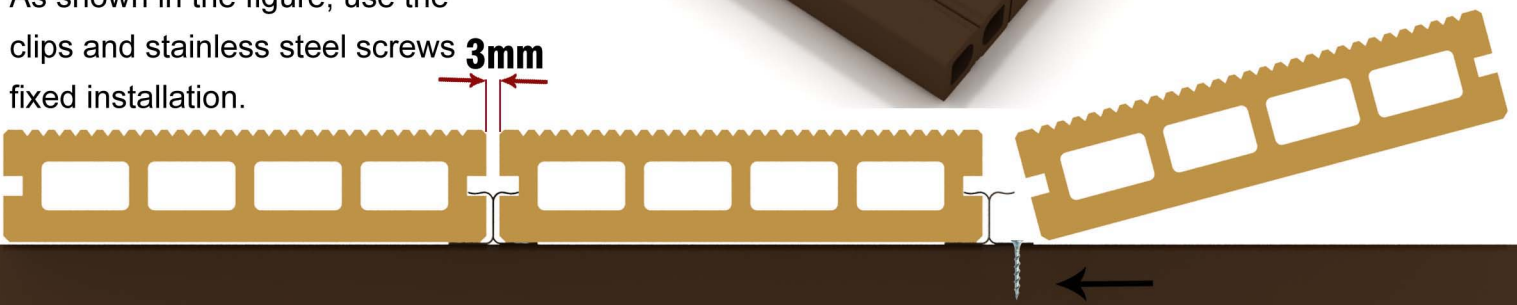

3

Composite Decking
COOWIN GROUP

Installation guide for high strength wpc decking

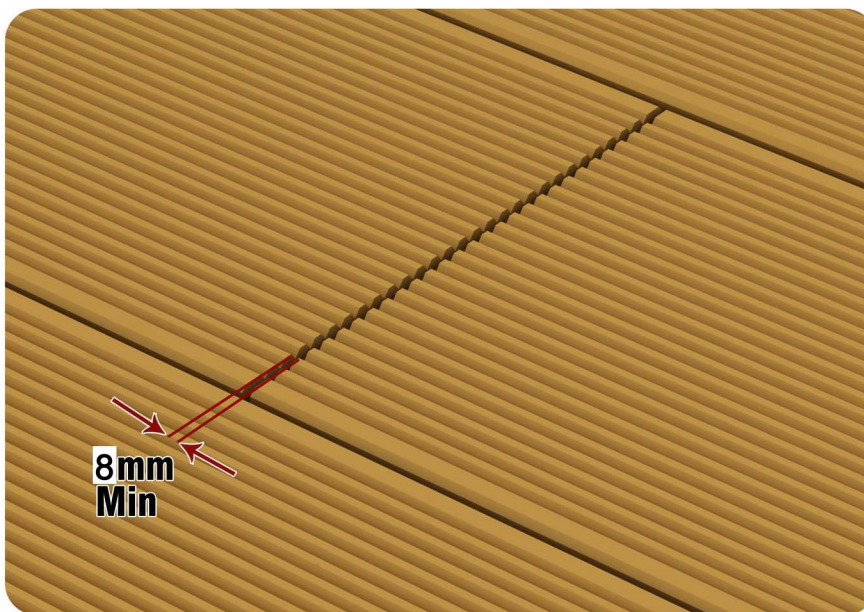
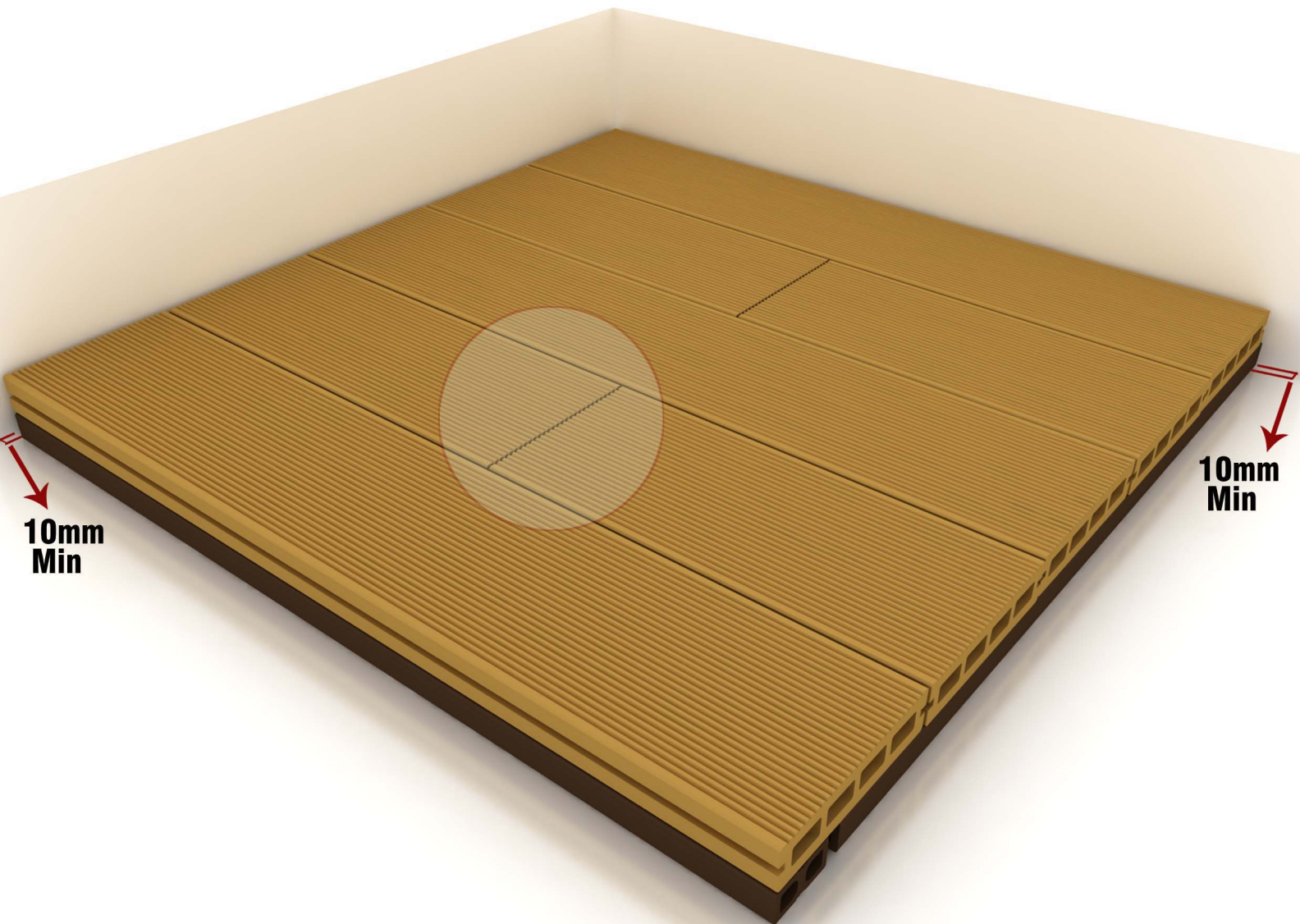

With the clips for reference, make sure the reserved expansion joints between two WPC decks at least 8mm.



4

Composite Decking
COOWIN GROUP

Installation guide for high strength wpc decking

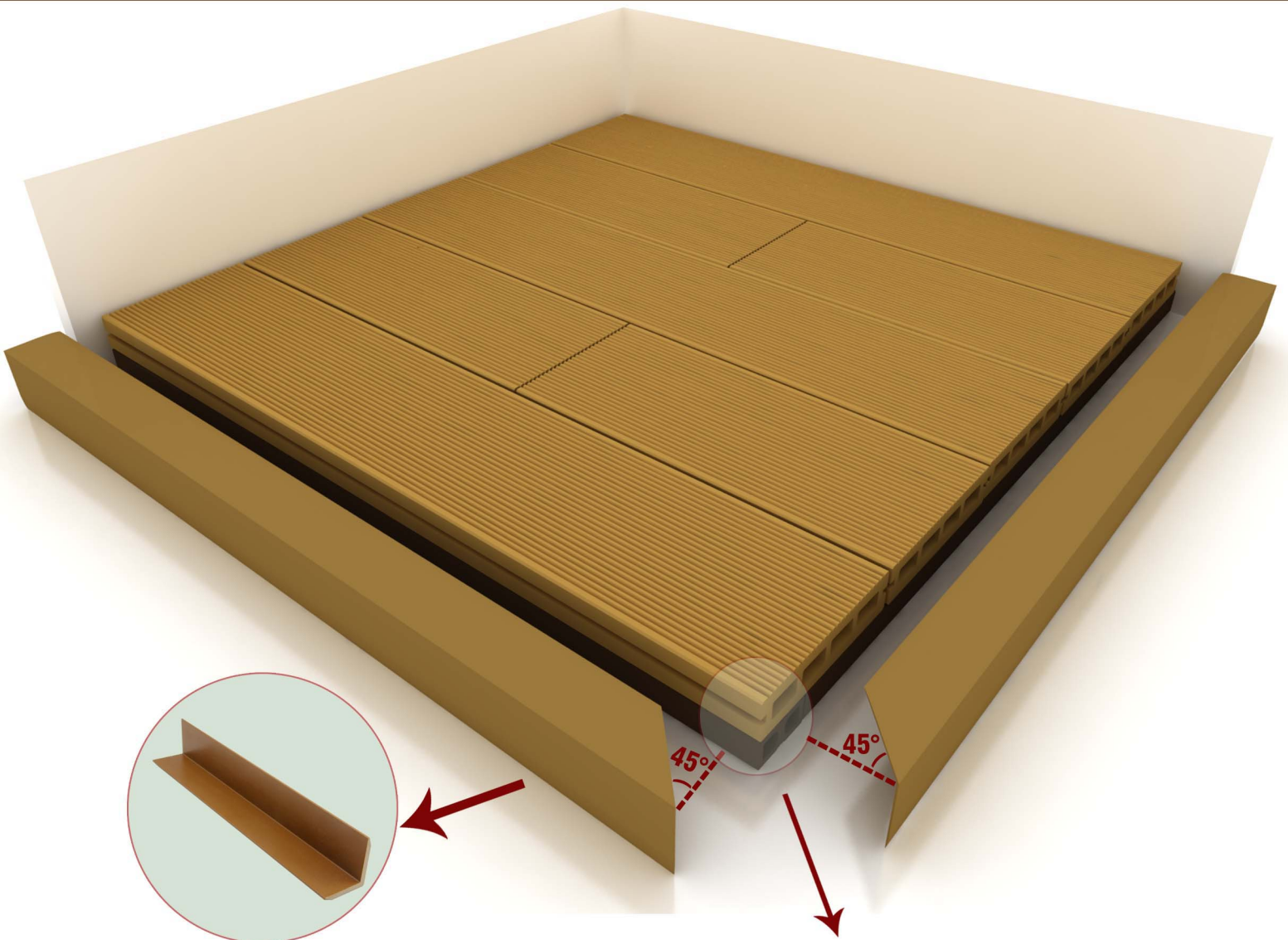

Cutting the L-corner to 45 degrees and stitching at the coner of the terrace decking.

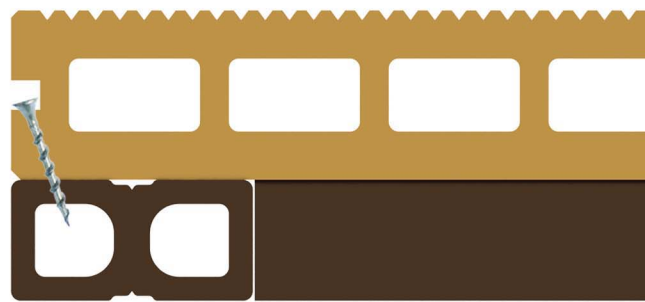

The WPC deck fixation, use the screw 45 degrees oblique drilled into the WPC deck and joist.

Fixed the L corner with screws to complete the installation.



5

Composite Decking
COOWIN GROUP

Installation guide for high strength wpc decking

Installation finished.

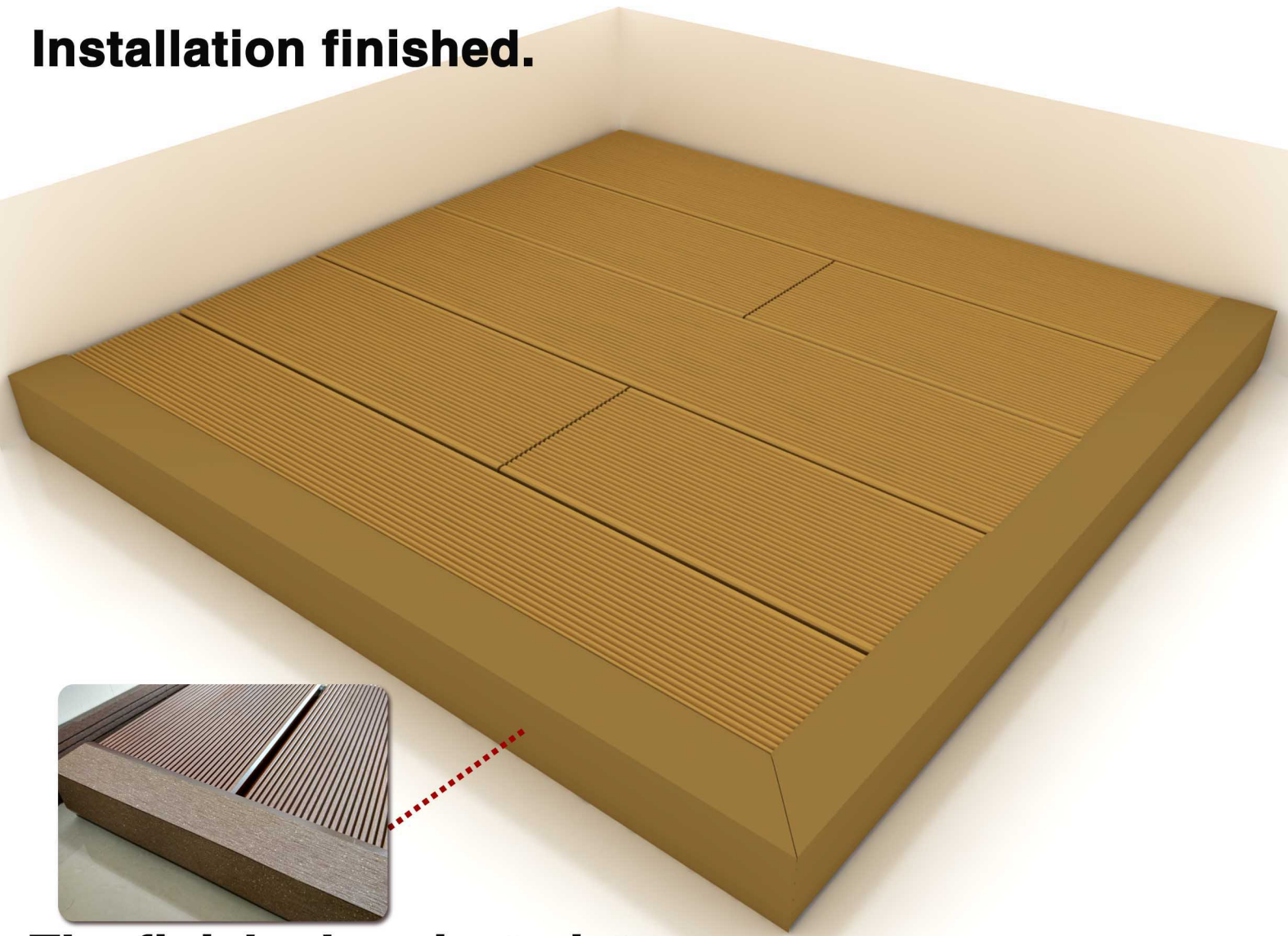

The finished project pictures.

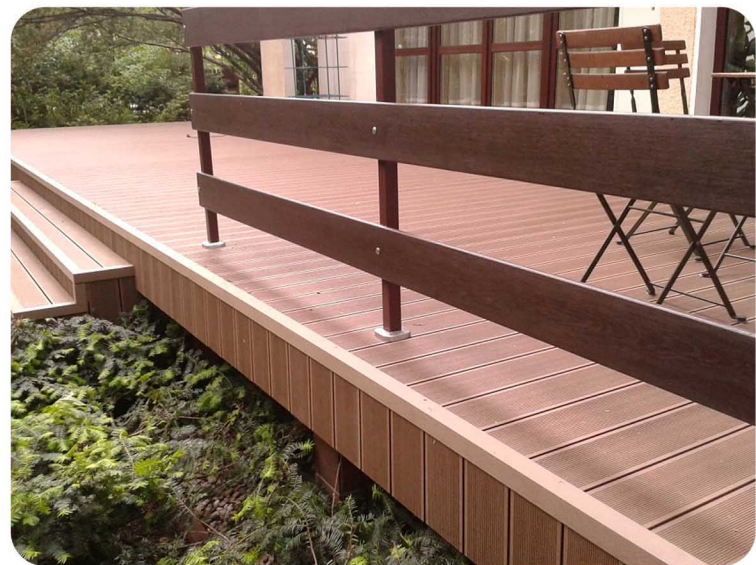

www.coowingroup.com

Tel: +86 532 67731461



6

Composite Decking
COOWIN GROUP

Fax: +86 532 67731463